

# **SINGER**

## **110W121**

# LIST OF PARTS



## MACHINE No. 110w121

THE SINGER MANUFACTURING COMPANY

## INDEX

	PAGE
ACCESSORIES .....	18
BOBBIN WINDER .....	18
FEEED GEARS .....	21
"    WHEELS .....	22
KNEE LIFTER .....	19
MACHINE No. 110w121 .....	7
NUMERICAL LIST OF PARTS .....	23

From the library of: Diamond Needle Corp

# Instructions for Ordering

In ordering from this list, use **ONLY** the **PART** number in the **FIRST** column.

The number stamped on a Sewing Machine Part is the number of the Single Part only, except when the part includes Set Screws, Clamping Screws, Studs and Rollers Spun on, Small Wires riveted, or Parts soldered together, etc., which it is necessary to furnish in combination.

Every combination of parts sent out has its specific number which, although not stamped on Parts (except in above cases) must be used when ordering the combination.

Each number always indicates the **SAME PART** in whatever list it appears, or for whatever Machine.

The letters after some of the numbers indicate the style of finish only, as follows:

- A. Hardened, Polished and Plated
- B. Polished and Plated.
- C. Hardened only.
- D. Polished only.
- E. Soft, not polished.
- F. Hardened and Polished.
- H. Blued.

These letters **MUST BE USED** when they appear in the list and **AFTER** the number, as in the list.

In this series

- 200001 to 201500 are Screw Numbers.
- 201501 to 201800 are Nut Numbers.
- 201801 to 202000 are Roller Numbers.
- 202001 and upward are numbers of Machine Parts.

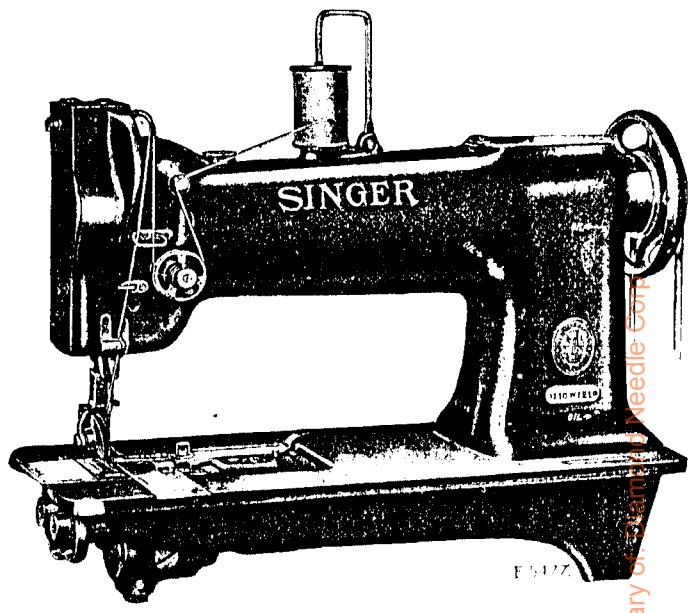
The figures in the second column refer only to the plate in which the illustration of the part is shown and are **NOT TO BE USED** in ordering.

Two or more numbers over a cut indicate that the difference between such parts is not visible in an illustration.

Parts marked with an asterisk (\*) are furnished only when repairs are made at the factory.

## LIST OF PARTS COMPLETE

FOR



### MACHINE No. 110w121

VERTICAL HOOK. ROLLER PRESSER. CONTINUOUS WHEEL FEED. HORIZONTAL UNDER TRIMMER

For Leather Work

No.	Plate	Name
*237701	---	Arm .....
202247	14377	" Cap .....
200278H	14176	" " Screw .....
202248	14176	" " " Washer .....
204235	14376	" Position Pin (2) .....
200010E	14176	" Screw (2) .....
200004E	14176	" " " .....
202005	14176	" " Washer (3) .....
237702	14178	" Shaft with 200357E and 203100 .....
237748	14377	" " Bushing (back) with 202299 .....
202299	---	Arm Shaft Bushing (back) Oil Packing (wick) .....

For the library of the Sewing Machine Needle Company

No.	Plate	Name
200071E	14176	Arm Shaft Bushing (back) Screw (3) .....
202245	14377	Arm Shaft Bushing (front) with 202036 and 202260 .....
202260	-----	Arm Shaft Bushing (front) Oil Packing (wick) .....
200502B	14176	Arm Shaft Bushing (front) Oil Packing Thumb Screw .....
202036	14176	Arm Shaft Bushing (front) Position Pin .....
200338c	14176	Arm Shaft Bushing (front) Set Screw .....
203100	-----	Arm Shaft Oil Packing (wick) ..
200357E	14176	" " " " Stop Screw ..
202632	14377	" Side Plate .....
200462B	14176	" " " Thumb Screw .....
223842	14178	Balance Wheel (belt groove 2 3/4 in. diam.) with 200328c and 200335c ..
200062H	14176	Balance Wheel Adjusting Screw ..
200328c	14176	" " Position Screw .....
200335c	14176	" " Set Screw .....
*238501	-----	Bed .....
202258	14377	" Hinge Connection (2) .....
200570E	14176	" " " Screw (4) .....
238502	14377	" Slide (back) .....
223811	14376	" " " Stop .....
223812	14376	" " " Spring .....
237706	14377	" " (front) .....
203470	14176	Bobbin .....
*203520	---	" Case .....
203648	14176	" " Latch .....
*202056	-----	" " " Pin .....
203473	14176	" " " Plunger .....
203474	14176	" " " Spring .....
236078	14176	" " Lever .....
*203476	-----	" " " Eccentric .....
204243	14176	" " " Position Pin .....
235751	14176	" " " Fulcrum .....
200056D	10884	" " " Screw .....
203478	14178	" " " Slide Stud .....
203214	14176	" " Tension Spring .....
200984c	14176	" " " " Regulat- ing Screw .....
200594c	14176	Bobbin Case Tension Spring Screw ..
203216	-----	" " Washer (cloth) .....
203521	14176	Bobbin Case complete, Nos. 200594c, 200984c, 202056, 203214, 203216, 203473, 203474, 203520 and 203648 ..
238503	14376	Edge Guide .....
201121D	14376	" " Screw (2) .....

No.	Plate	Name
210911	14377	Face Plate .....
202135	14176	" " Position Pin .....
200473E	14176	" " Thumb Screw .....
237771	14382	Feed Wheel (knurled) .....
350085E	14179	" " Adjusting Screw .....
237708	14179	" " " " Block .....
237709	14180	" " Bracket .....
237710	14179	" " " Spring .....
237713	14179	" " Driving Gear with 200382c and 201220c (for 16 stitches) .....
201220c	14179	Feed Wheel Driving Gear Position Screw .....
200382c	14179	Feed Wheel Driving Gear Set Screw ..
237718	14179	" " " Pinion with 200382c and 201220c (for 16 stitches) .....
201220c	14179	Feed Wheel Driving Pinion Position Screw .....
200382c	14179	Feed Wheel Driving Pinion Set Screw .....
237721	14178	Feed Wheel Driving Shaft .....
237722	14179	" " " Bushing (back) .....
237723	14179	Feed Wheel Driving Shaft Bushing (front) .....
200362c	14179	Feed Wheel Driving Shaft Bushing Set Screw .....
221743	14179	Feed Wheel Driving Shaft Collar with two 200380c .....
200380c	14179	Feed Wheel Driving Shaft Collar Set Screw .....
237724	14179	Feed Wheel Driving Shaft Gear with 200378c and 201220c .....
201220c	14179	Feed Wheel Driving Shaft Gear Position Screw .....
200378c	14179	Feed Wheel Driving Shaft Gear Set Screw .....
237725	14179	Feed Wheel Stud .....
201697c	14179	" " " Nut .....
*203482	---	Hook (sewing) .....
237726	14181	" 203482 with 201253E, 201376E and 221148 .....
237727	-----	Hook and Bobbin Case complete, Nos. 203521 and 237726 .....
235755	14181	Hook Bevel Gear Socket, 18 teeth ..
235527	14181	" " " " Bushing (lower) (brass) .....
200362c	14179	Hook Bevel Gear Socket Bushing (lower) Set Screw .....

No.	Plate	Name
235756	14181	Hook Bevel Gear Socket Bushing (upper) (brass) .....
449c	14181	Hook Bevel Gear Socket Bushing (upper) Set Screw .....
200555H	14181	Hook Bevel Gear Socket Screw ...
235635	14181	" " " " Thrust Washer .....
235529	14181	Hook Driving Bevel Gear with two 350089c .....
350089c	14181	Hook Driving Bevel Gear Set Screw
237728	14178	" " Shaft .....
235857	14181	" " " Bevel Gear with 200374c and 200396c .....
237729	14180	Hook Driving Shaft Bevel Gear Housing with 200346c and three 200362c .....
237730	14180	Hook Driving Shaft Bevel Gear Housing Cap (bottom) .....
237731	14180	Hook Driving Shaft Bevel Gear Housing Cap (bottom) Gasket ..
237732	14180	Hook Driving Shaft Bevel Gear Housing Cap (side) .....
237733	14180	Hook Driving Shaft Bevel Gear Housing Cap (side) Gasket ....
200053c	14181	Hook Driving Shaft Bevel Gear Housing Cap Screw (4) .....
201082E	14181	Hook Driving Shaft Bevel Gear Housing Screw (long) .....
225532	14376	Hook Driving Shaft Bevel Gear Housing Screw (long) Washer ..
201308E	14181	Hook Driving Shaft Bevel Gear Housing Screw (short) .....
200396c	11607	Hook Driving Shaft Bevel Gear Position Screw .....
200374c	14181	Hook Driving Shaft Bevel Gear Set Screw .....
237734	14181	Hook Driving Shaft Bushing (back)
200362c	14179	" " " " " " Set Screw .....
235531	14189	Hook Driving Shaft Bushing (front)
200347c	14181	" " " " " " Set Screw .....
221743	14179	Hook Driving Shaft Collar with two 200380c .....
200380c	14179	Hook Driving Shaft Collar Set Screw .....
221148	14181	Hook Gib .....
201376F	14181	" " Hinge Screw .....
201253F	14181	" " Screw .....

No.	Plate	Name
237735	14180	Hook Saddle with 449c, 200347c and three 200362c .....
235534	14376	Hook Saddle Oil Cover .....
201185D	14376	" " " " Screw (2) ..
201318E	14376	" " " " Stop Screw (2) ..
235535	"	" " Oiling Felt .....
202260	"	" " " Wick .....
235649	14376	" " " " Cover .....
200169H	14376	" " " " " Screw
201308E	14181	" " Screw (2) .....
213018	14376	" Washer with 203476 and two 204243 .....
208490	14377	Knee Lifter Connection Lever ....
200262H	14376	" " " " Hinge Screw .....
237766	14378	Knee Lifter Connection Lever Lifting Rod with 202302 .....
202302	14376	Knee Lifter Connection Lever Lifting Rod Cotter Pin .....
202687	14378	Knee Lifter Lifting Lever .....
200262H	14376	" " " " Hinge Screw .....
238504	14376	Knife .....
200392c	14376	" Adjusting Screw .....
238509	14376	" Driving Eccentric with two 200386c .....
238510	14378	Knife Driving Eccentric Oil Pan
201058E	14376	" " " " " " Screw (2) .....
200386c	14376	Knife Driving Eccentric Set Screw
238511	14376	" " Fork with two 206758
238512	14376	" " " Lever .....
238513	14378	" " " " Bracket with 200378c .....
202126	14376	Knife Driving Fork Lever Bracket Position Pin (2) .....
201058E	14376	Knife Driving Fork Lever Bracket Screw (2) .....
210910	11607	Knife Driving Fork Lever Hinge Stud with 202277 .....
202277	-----	Knife Driving Fork Lever Hinge Stud Oil Packing (wick) .....
200378c	14179	Knife Driving Fork Lever Hinge Stud Set Screw .....
206758	-----	Knife Driving Fork Oil Packing (wick) .....
200080D	14376	Knife Driving Fork Screw .....
238522	14376	" " " " Bearing
232321	14379	" " " Slide Block

No.	Plate	Name
200252c	14379	Knife Driving Fork Slide Block Hinge Screw .....
201528E	14379	Knife Driving Fork Slide Block Hinge Screw Nut .....
238514	14378	Knife Driving Lever .....
238515	14378	" " " Hinge Plate .....
1094F	14379	" " " " " Screw (2) .....
350154E	14379	Knife Driving Lever Hinge Screw .....
238516	14379	" " " " " Bearing .....
238517	14379	Knife Lever with 200392c .....
238518	14379	" " Hinge Bearing .....
350155B	14379	" " Screw .....
200169n	14376	" Screw (2) .....
237937	14379	Needle Bar with 200141F .....
202552	11607	" " Connecting Link ....
223687	14379	" " " " Oil Guard .....
200161D	11607	Needle Bar Connecting Link Oil Guard Screw .....
202333	11607	Needle Bar Connecting Link Stud with 202254 .....
202254	----	Needle Bar Connecting Link Stud Oil Packing (wick) .....
200374c	14181	Needle Bar Connecting Link Stud Set Screw .....
200383c	14379	Needle Bar Connecting Link Stud Set Screw .....
*206891	----	Needle Bar Connecting Stud ....
202329	11607	" " " " 206891 with 200086c and 202330 .....
202330	----	Needle Bar Connecting Stud Oil Packing (wick) .....
200086c	11607	Needle Bar Connecting Stud Pinch Screw .....
202692	14183	Needle Bar Crank with 200335c, 200374c, 200383c, 200428c and 202333 .....
237737	----	Needle Bar Crank 202692 with 202329, 202399, 202400, 202552 and 237762 .....
203172	11607	Needle Bar Crank Friction Washer .....
200428c	11607	" " " Position Screw ..
200335c	14176	" " " Set Screw .....
202664	14183	" " Rock Frame .....
237738	----	" " " " 202664 with 237937 .....
*38127	----	Needle Bar Rock Frame Driving Eccentric .....

No.	Plate	Name
*237749	----	Needle Bar Rock Frame Driving Eccentric Body .....
350107c	14378	Needle Bar Rock Frame Driving Eccentric Body Position Screw ..
443c	14379	Needle Bar Rock Frame Driving Eccentric Body Set Screw .....
21331	14379	Needle Bar Rock Frame Driving Eccentric Pressure Spring .....
21332	14379	Needle Bar Rock Frame Driving Eccentric Pressure Spring Cap ..
934D	14379	Needle Bar Rock Frame Driving Eccentric Pressure Spring Cap Screw .....
1103c	14379	Needle Bar Rock Frame Driving Eccentric Regulating Screw ....
217D	14379	Needle Bar Rock Frame Driving Eccentric Set Screw .....
7071	14379	Needle Bar Rock Frame Driving Eccentric Set Screw Washer ...
237750	----	Needle Bar Rock Frame Driving Eccentric complete, Nos. 217D, 443c, 934D, 1103c, 7071, 21331, 21332, 38127, 237749 and 350107c
237739	14183	Needle Bar Rock Frame Driving Fork Lever with 200029E .....
200029E	14379	Needle Bar Rock Frame Driving Fork Lever Pinch Screw .....
237740	14379	Needle Bar Rock Frame Driving Fork Lever Slide Block (two pieces) .....
210910	11607	Needle Bar Rock Frame Hinge Stud with 202277 .....
202277	----	Needle Bar Rock Frame Hinge Stud Oil Packing (wick) .....
200347c	14181	Needle Bar Rock Frame Hinge Stud Set Screw .....
202666	11607	Needle Bar Rock Frame Position Bracket .....
200098E	11607	Needle Bar Rock Frame Position Bracket Screw .....
202667	14378	Needle Bar Rock Frame Rock Shaft .....
210978	----	" " " " " " 202667 with 200386c and 210920 ..
202668	11607	Needle Bar Rock Frame Slide Block .....
210920	14380	" " " " " " 202668 with 201141c .....
201141c	14380	Needle Bar Rock Frame Slide Block Screw Stud .....
200386c	14376	Needle Bar Rock Frame Slide Block Screw Stud Set Screw .....

No.	Plate	Name
200141F	11607	Needle Set Screw .....
207072	11607	Presser Bar Bushing (2) .....
200352c	14380	" " " Set Screw (2)
202671	14380	" " " Lifter .....
200653c	14380	" " " Hinge Screw ..
202672	14380	" " " Lifting Releasing Lev- er Bracket .....
200975F	14380	Presser Bar Lifting Releasing Lev- er Bracket Guide Screw .....
237765	14380	Presser Bar Lifting Releasing Lev- er Bracket Spring (spiral) .....
202337	14380	Presser Bar Position Guide .....
202338	14380	" " " " Lever with 200086F .....
200086F	11607	Presser Bar Position Guide Lever Pinch Screw .....
200352c	14380	Presser Bar Position Guide Set Screw .....
210948	14378	Presser Bar Spring (flat) .....
210949	14380	" " " Bracket with 200086c .....
200086c	11607	Presser Bar Spring Bracket Pinch Screw .....
200538c	14380	Presser Bar Spring Regulating Screw .....
200948c	14380	Presser Bar Spring Support Screw
201971	-----	Roller Presser, 1 1/4 in. diam., 3/8 in. face (fine) .....
201972	14380	Roller Presser 201971 with 1528J, 1766c, 50553c and twenty-four 16232 .....
203426	14380	Roller Presser Arm .....
238527	-----	" " " " 203426 with 201972 .....
202560	14380	Roller Presser Arm Bracket (swing)
238528	-----	" " " " " 202560 with 200096D and 238527 .....
200675c	14380	Roller Presser Arm Bracket Posi- tion Screw Stud .....
202558	14380	Roller Presser Arm Bracket Spring
202559	14380	" " " " " "
		Stop .....
200141F	11607	Roller Presser Arm Bracket Spring Stop Screw .....
200096D	14380	Roller Presser Arm Screw .....
16232	-----	" " " Ball, 3/8 in. diameter
1766c	14380	" " " Cone .....
202557	14183	" " " Bar .....
50553c	14380	" " " Hinge Screw .....
1528J	14380	" " " " Nut .....

No.	Plate	Name
238529	14378	Roller Presser and Bar complete, Nos. 200675c, 202557 to 202559, 238528 and two 200141F .....
202068	14183	Spool Holder Base .....
200575H	14381	" " " Screw .....
204296	14183	" " " Wire .....
200079H	14381	" " " Hinge Screw .....
204297	14183	Spool Holder complete, Nos. 200079H, 202068 and 204296 .....
237762	14381	Take-up Lever .....
202399	14381	" " " Driving Stud with 202277 .....
202277	-----	Take-up Lever Driving Stud Oil Packing (wick) .....
202400	14381	Take-up Lever Hinge Stud with 202423 .....
202423	---	Take-up Lever Hinge Stud Oil Packing (wick) .....
200363c	14381	Take-up Lever Hinge Stud Set Screw .....
202401	---	Take-up Lever Oiling Felt .....
200132E	14381	" " " " " Screw
202402	11610	Tension Disc (back) .....
210967	11610	" " (front) .....
210950	14381	" Release Driving Lever with 200394c and 202676 .....
202676	14381	Tension Release Driving Lever Pin
202677	14381	" " " " " "
		Slide Bar .....
210966	---	Tension Release Driving Lever Pin Slide Bar 202677 with 200167E and 210952 .....
202678	14381	Tension Release Driving Lever Pin Slide Bar Spring .....
200394c	14381	Tension Release Driving Lever Set Screw .....
210951	11610	Tension Release Washer .....
202407	10881	" Spring .....
200625F	11610	" Stud with 204925 .....
200061c	14381	" " Set Screw .....
204925	11610	" " Washer .....
201572B	10881	" Thumb Nut .....
210953	11610	Tension complete, Nos. 200625F, 201572B, 202402, 202407, 202682, 210951 and 210967 .....
202682	11610	Thread Controller Spring .....
210952	11610	" " " Stop .....
200167E	11610	" " " " Screw
210955	11610	" Guide (upper) .....

No.	Plate	Name
200582n	11610	Thread Guide Screw (2) .....
204329		" Oiler (felt) .....
237770	14381	" " Bracket with 204329 ..
200582n	11610	" " " Screw .....
210956	11610	" Retainer Bracket with 200397n
200582n	11610	" " " Screw (2) ..
210960	11610	" " Disc .....
210961	11610	" " Plunger .....
210962	11610	" " " Spring .....
210993	11610	" " Sleeve .....
210963	11610	" " Socket .....
200368n	14381	" " " Set Screw ....
223844	14381	" " Spring .....
210957	11610	" " Stud .....
210958	11610	" " " Collar .....
200397n	11610	" " " Set Screw ....
210959	11610	Thread Retainer (lower) complete, Nos. 210956 to 210958, 210993 and 223844 .....
238524		Throat Plate Body .....
238525		" " Needle Plate, 56 elongated needle hole, for needle sizes 12 and 13 .....
200583n	14381	Throat Plate Needle Plate Screw ..
1094r	14379	" " Screw (2) .....
238526	14381	Throat Plate complete, 56 elongated needle hole, for needle sizes 12 and 13, Nos. 238524, 238525 and two 200583n .....
237744	14183	Vertical Shaft .....
237745	14381	" " Bevel Gear (lower)
205508	14381	" " " " "
		Position Pin .....
235857	14181	Vertical Shaft Bevel Gear (upper) with 200374c and 200396c .....
200396c	11607	Vertical Shaft Bevel Gear (upper) Position Screw .....
200374c	14181	Vertical Shaft Bevel Gear (upper) Set Screw .....
237734	14181	Vertical Shaft Bushing (lower) ...
200346c	14381	" " " " Set Screw .....
237746	14378	Vertical Shaft Bushing (upper) ...
200362c	14179	" " " " Set Screw .....
237747	14381	Vertical Shaft Driving Gear with 200374c and 200396c .....
200396c	11607	Vertical Shaft Driving Gear Position Screw .....

No.	Plate	Name
200374c	14181	Vertical Shaft Driving Gear Set Screw .....
237754	14381	Vertical Shaft Oil Leader (lower) (brass) .....
237755	14381	Vertical Shaft Oil Leader (upper) (brass) .....



## ACCESSORIES

No.	Plate	Name
203470	14176	Bobbin (5) .....
*225482	-----	" Case Screw Driver Blade ...
*225483	-----	" " " " Handle ...
225497	14383	Bobbin Case Screw Driver complete, Nos. 225482 and 225483 ...
237714	-----	Feed Wheel Driving Gear with 200382c and 201220c (for 17½ stitches) .....
237715	-----	Feed Wheel Driving Gear with 200382c and 201220c (for 19 stitches) .....
237719	-----	Feed Wheel Driving Pinion with 200382c and 201220c (for 17½ stitches) .....
237720	-----	Feed Wheel Driving Pinion with 200382c and 201220c (for 19 stitches) .....
238504	14376	Knife .....
4822	14195	Roller Presser Hinge Screw Nut Wrench .....
16 x 4	-----	Needles, two each, sizes 12, 14 and 16 .....
237757	-----	Drip Pan with four wood screws ½ in., No. 5 .....
41400	14383	Machine Rest Pin (wood) .....
120342	14383	Oiler (copper plated) with 120343 ..
120343	14383	" Spout, 3½ in. long .....
*225484	-----	Screw Driver Blade .....
*225485	-----	" " Handle .....
225498	14383	Screw Driver complete (7½ in. long), Nos. 225484 and 225485 ...
225554	14383	Wrench (steel) .....

### BOBBIN WINDER

#### Swing Automatic, Right Hand

225453	10884	Frame with 202277 and 225438 ...
225454	10884	" Hinge Pin .....
202277	-----	" Oil Packing (wick) .....
225438	10884	" " Well Cap .....
225455	10884	" Spring .....
225456	10884	" " Plunger .....
202473	10885	Pulley with 200380c .....
200380c	14179	" Set Screw .....

No.	Plate	Name
225381	10884	Spindle .....
225444	10884	Stop Latch .....
200056e	10884	" " Screw .....
225458	10884	" " Thumb Lever .....
225459	10884	Stop Latch Thumb Lever Hinge Stud .....
225460	10884	Stop Latch Thumb Lever Joint Stud .....
202478	10884	Stop Latch Trip Lever .....
200299h	10884	" " " " Hinge Screw
225461	10881	Tension Bracket with 201499b ....
200082b	10881	" " Screw .....
228026	10884	" " " Washer .....
2102	10881	" Disc .....
202407	10881	" Spring .....
201499b	10881	" Stud .....
201572b	10881	" " Thumb Nut .....
225462	10881	Bobbin Winder Tension Bracket complete, Nos. 201572b, 202407, 225461 and two 2102 .....
225433	10885	Bobbin Winder and Tension Bracket Base .....
225382	10885	Universal Bobbin Winder complete, Nos. 200056e, 200082b, 200299h, 202473, 202478, 225381, 225433, 225444, 225453 to 225456, 225458 to 225460, 225462, 228026 and two wood screws ¾ in., No. 13, R.H.B.

### KNEE LIFTER

227781	14384	Knee Lifter Rock Lever with 200522c and 200529c .....
227782	-----	Knee Lifter Rock Lever 227781 with two each 202451 and 202452
227787	14384	Knee Lifter Rock Lever 227782 with 202203 and 227728 .....
202453	14384	Knee Lifter Rock Lever Knee Plate with 200526c .....
202203	-----	Knee Lifter Rock Lever Knee Plate 202453 with 202454 .....
202454	14384	Knee Lifter Rock Lever Knee Plate Arm .....
200522c	14195	Knee Lifter Rock Lever Knee Plate Arm Set Screw .....
200526c	14195	Knee Lifter Rock Lever Knee Plate Set Screw .....
202451	14384	Knee Lifter Rock Lever Lug with two wood screws ¾ in., No. 13 ...

From the library of: Diamond Needle Corp

No.	Plate	Name
202452	14384	Knee Lifter Rock Lever Lug Hinge Pin .....
227728	14384	Knee Lifter Rock Lever Rod, 3 in. long, with 227729 .....
*227729	-----	Knee Lifter Rock Lever Rod Cap or Oil Guard .....
200529c	14195	Knee Lifter Rock Lever Rod Set Screw .....

(Other Knee Lifter parts are listed with parts of machine head).

## FEED GEARS

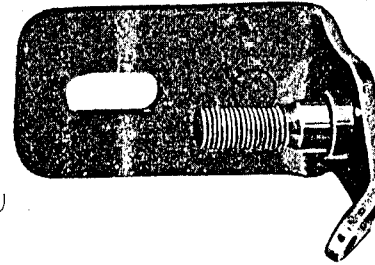
No.	Plate	Name
237763	14195	Feed Wheel Driving Gear with 200382c and 201220c (for 12 stitches) .....
237711	-----	Feed Wheel Driving Gear with 200382c and 201220c (for 14 stitches) .....
237712	-----	Feed Wheel Driving Gear with 200382c and 201220c (for 15 stitches) .....
237713	14179	Feed Wheel Driving Gear with 200382c and 201220c (for 16 stitches) .....
237714	-----	Feed Wheel Driving Gear with 200382c and 201220c (for 17½ stitches) .....
237715	-----	Feed Wheel Driving Gear with 200382c and 201220c (for 19 stitches) .....
237751	-----	Feed Wheel Driving Gear with 200382c and 201220c (for 23 stitches) .....
237764	14195	Feed Wheel Driving Pinion with 200382c and 201220c (for 12 stitches) .....
237716	-----	Feed Wheel Driving Pinion with 200382c and 201220c (for 14 stitches) .....
237717	-----	Feed Wheel Driving Pinion with 200382c and 201220c (for 15 stitches) .....
237718	14179	Feed Wheel Driving Pinion with 200382c and 201220c (for 16 stitches) .....
237719	-----	Feed Wheel Driving Pinion with 200382c and 201220c (for 17½ stitches) .....
237720	-----	Feed Wheel Driving Pinion with 200382c and 201220c (for 19 stitches) .....
237752	-----	Feed Wheel Driving Pinion with 200382c and 201220c (for 23 stitches) .....

# FEED WHEELS

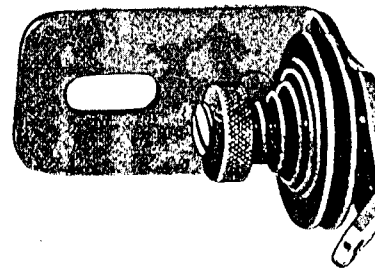
No.	Plate	Name
238523	14382	Feed Wheel .....
237767	14382	" " (coarse) .....
237771	14382	" " (knurled) .....

## PLATE 10881—FULL SIZE

225461



225462



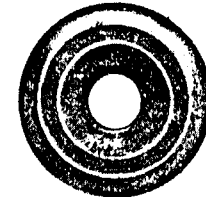
200082



202104



2102



202407



201499



201572



PLATE 10884—FULL SIZE

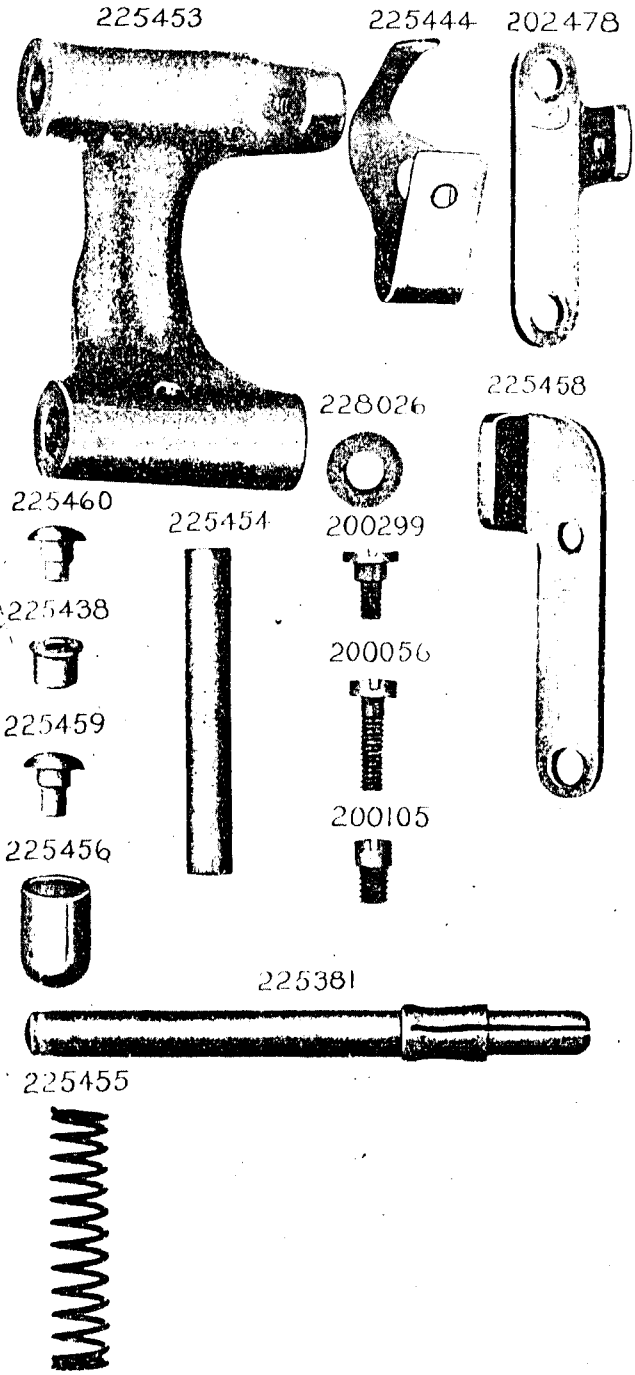
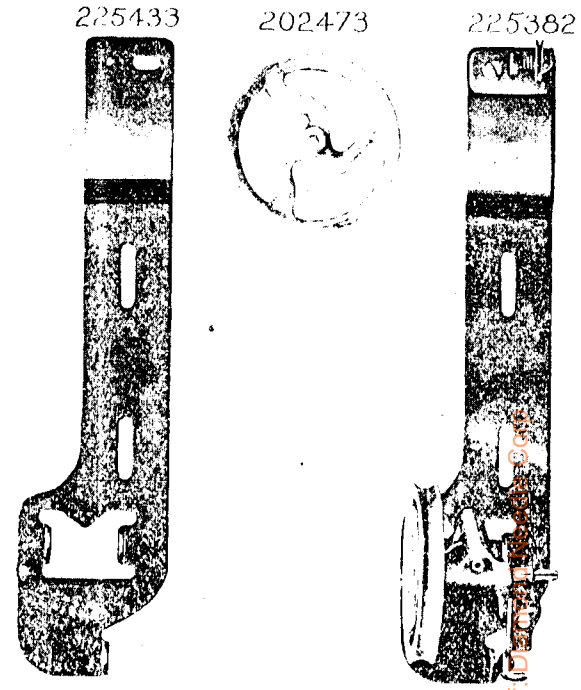


PLATE 10885—ONE-FOURTH SIZE



From the library of <http://www.gpo.gov>

PLATE 11607--FULL SIZE

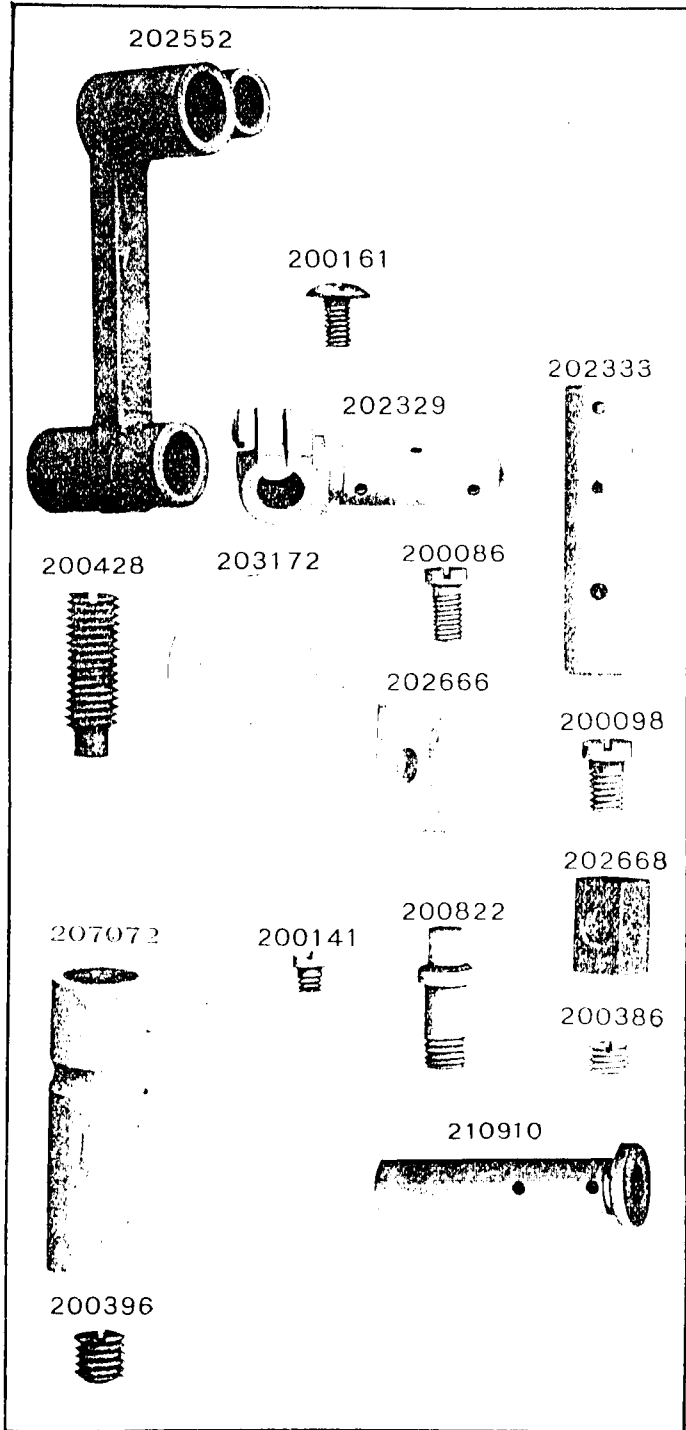


PLATE 11610--FULL SIZE

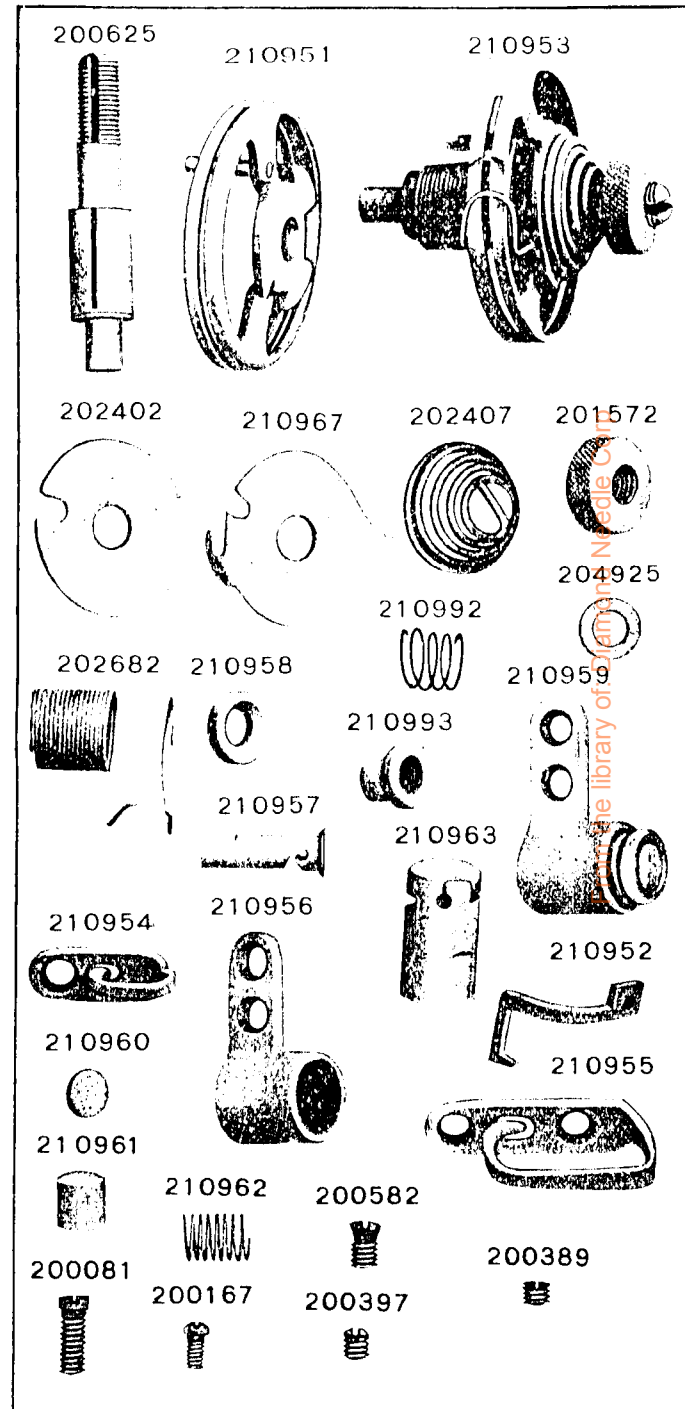


PLATE 14176—FULL SIZE

200278 202248 200071 202036 200338

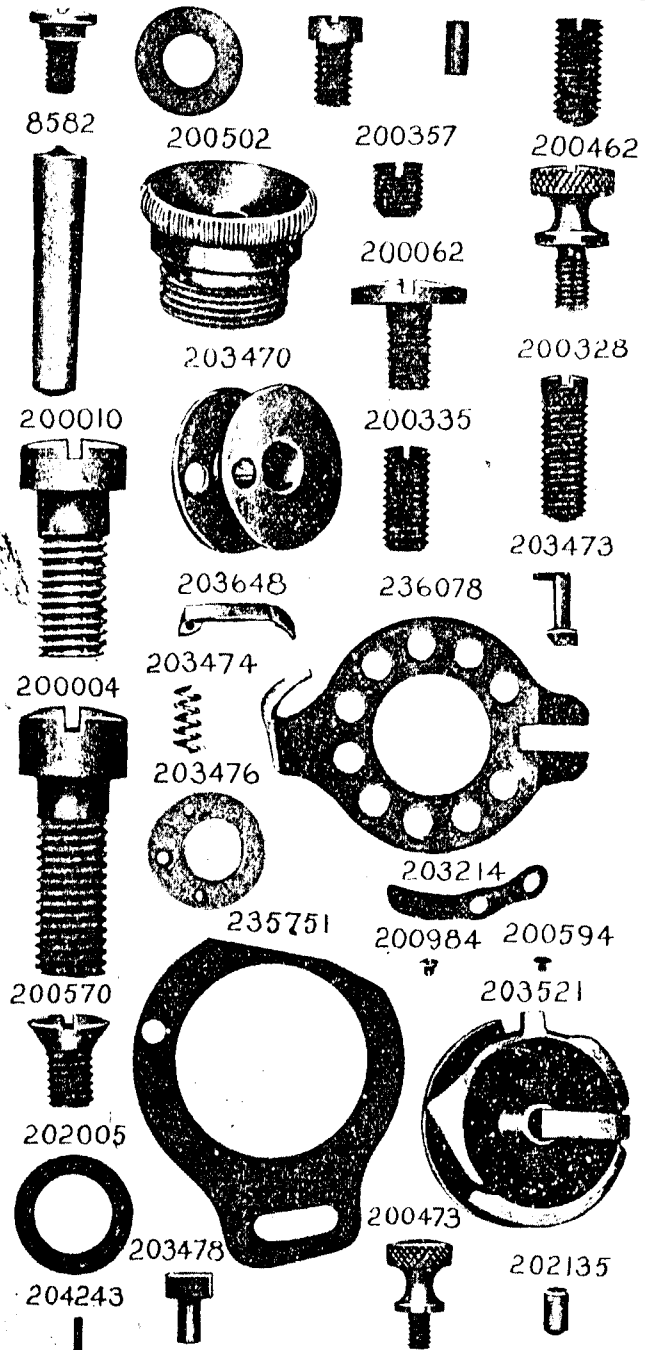
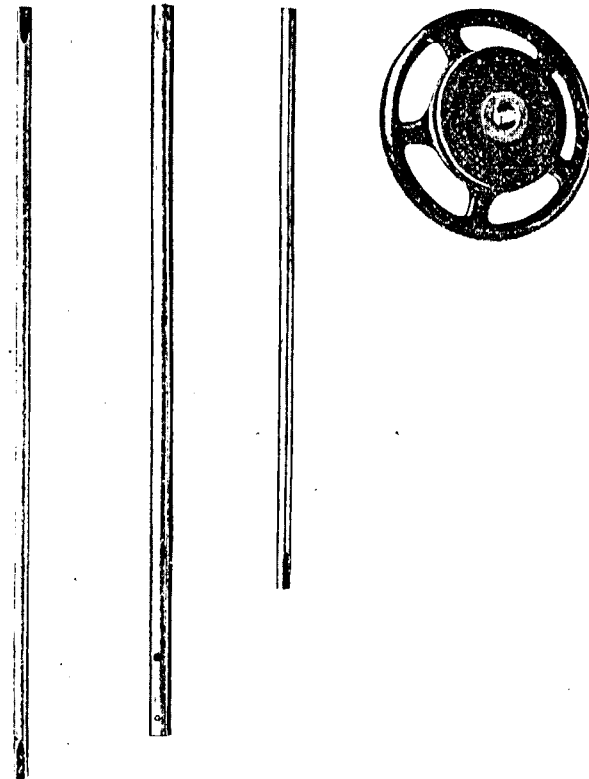


PLATE 14178—ONE-FOURTH SIZE

237721 237702 237728 223842



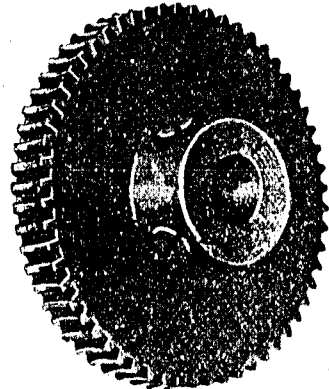
From the library of: Diamond Needle Corp

PLATE 14179—FULL SIZE

237723



237724



200378



200382



201220



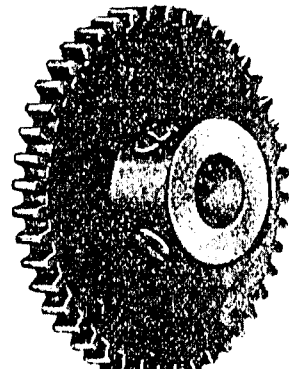
200362



200380



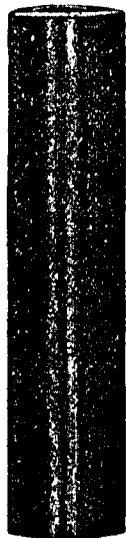
237713



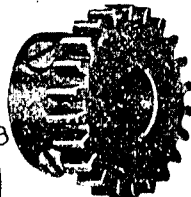
221743



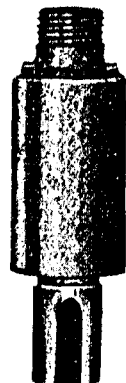
237722



237718



237725



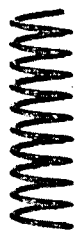
237708



350085



237710

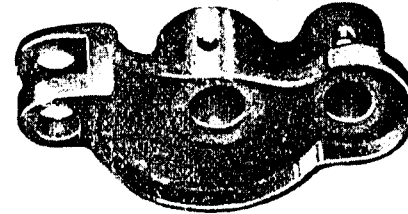


201697

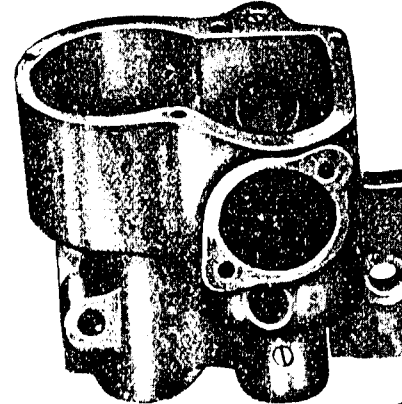


PLATE 14180—ONE-HALF SIZE

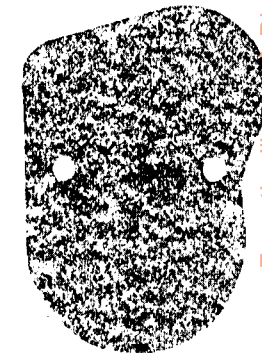
237709



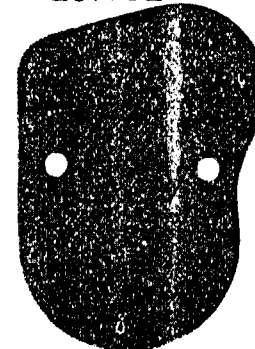
237729



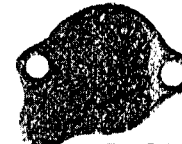
237733



237732



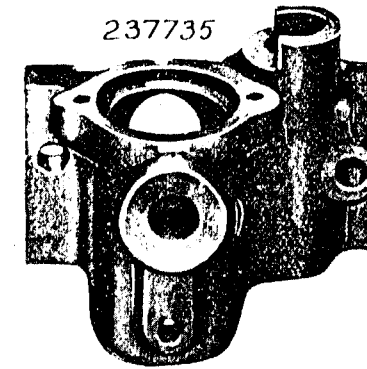
237730



237731



237735



From the library of: Diamond Needle Corp

PLATE 14181—FULL SIZE

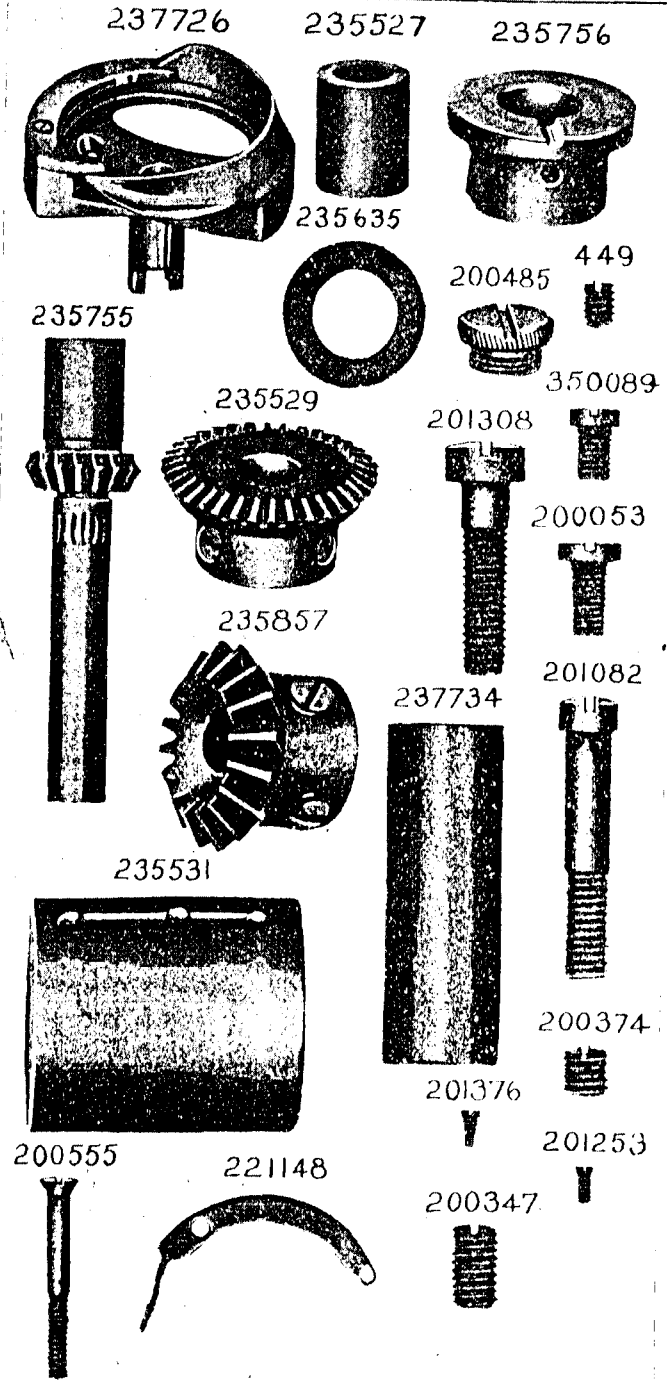
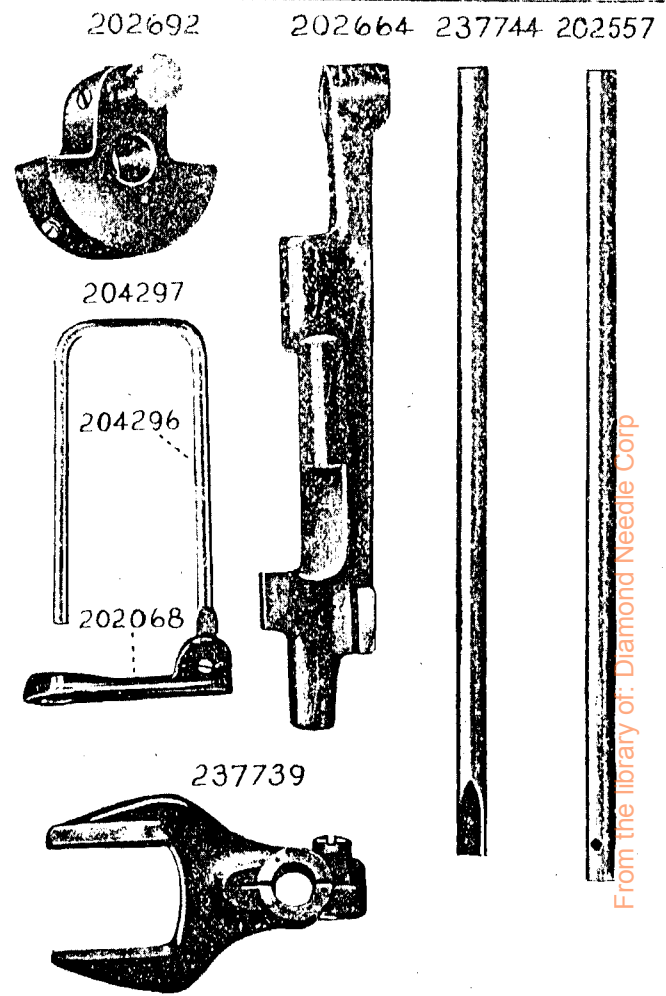


PLATE 14183—ONE-HALF SIZE



From the library of: Diamond Needle Corp

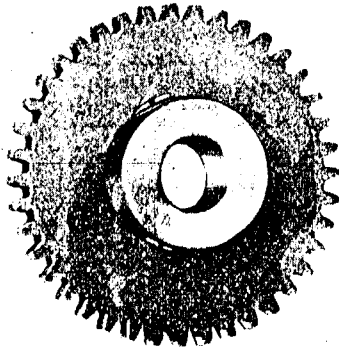


PLATE 14195—FULL SIZE

4822 200522 200526 200529



237763



202452



237764

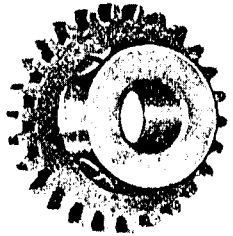
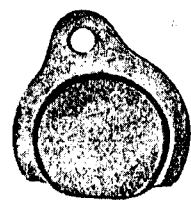
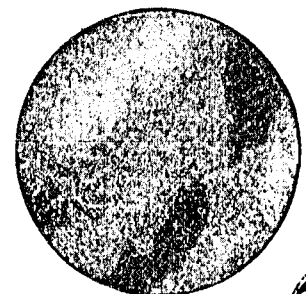


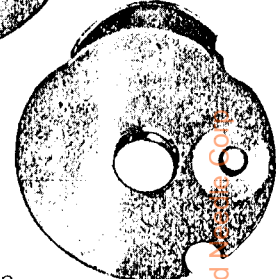
PLATE 14376—FULL SIZE

238503 235534 235649

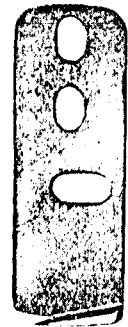


213018

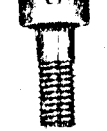
202302



238504



201058



204235



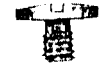
225532



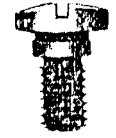
223811



201185



200262



204235



225532



223811



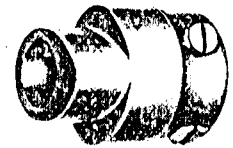
223812



201318



238509



201121



200169



200386



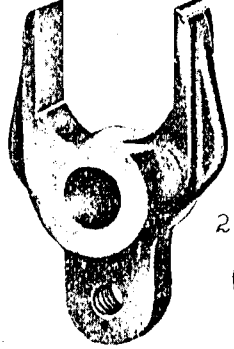
200392



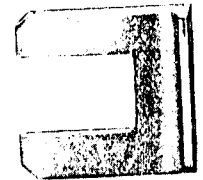
202126



238512



238511



238522



200080



PLATE 14377—ONE-HALF SIZE

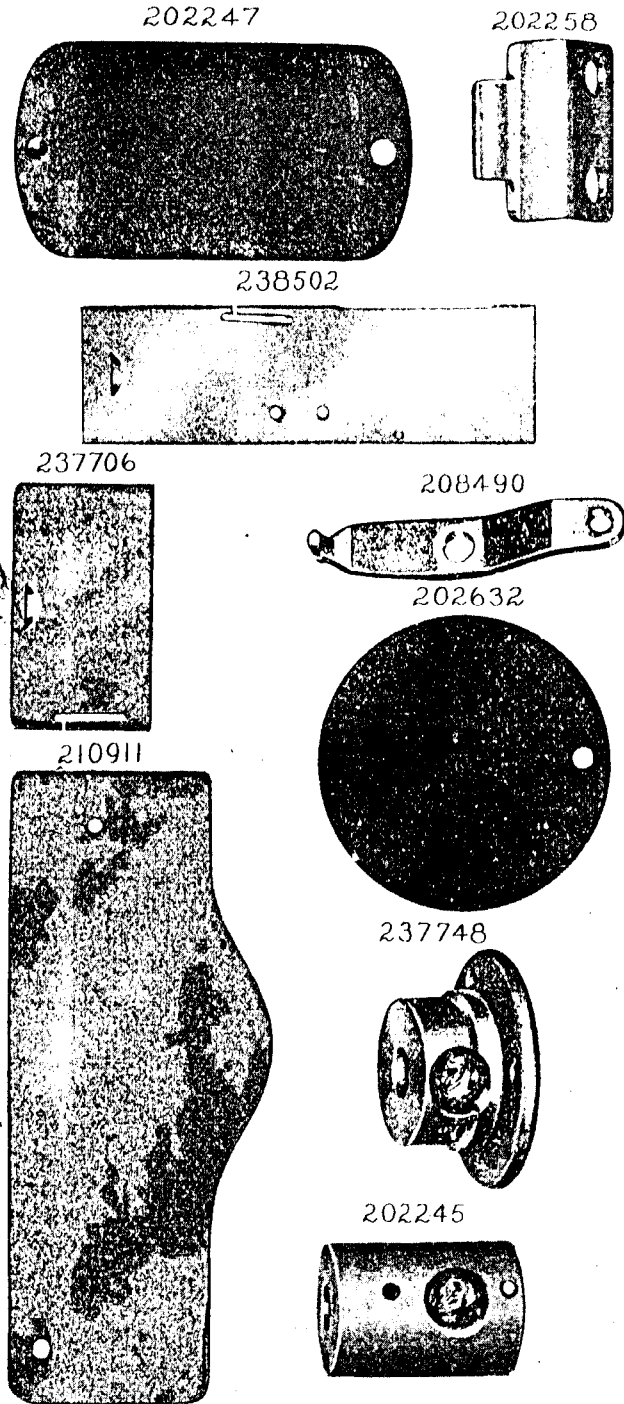


PLATE 14378—ONE-HALF SIZE

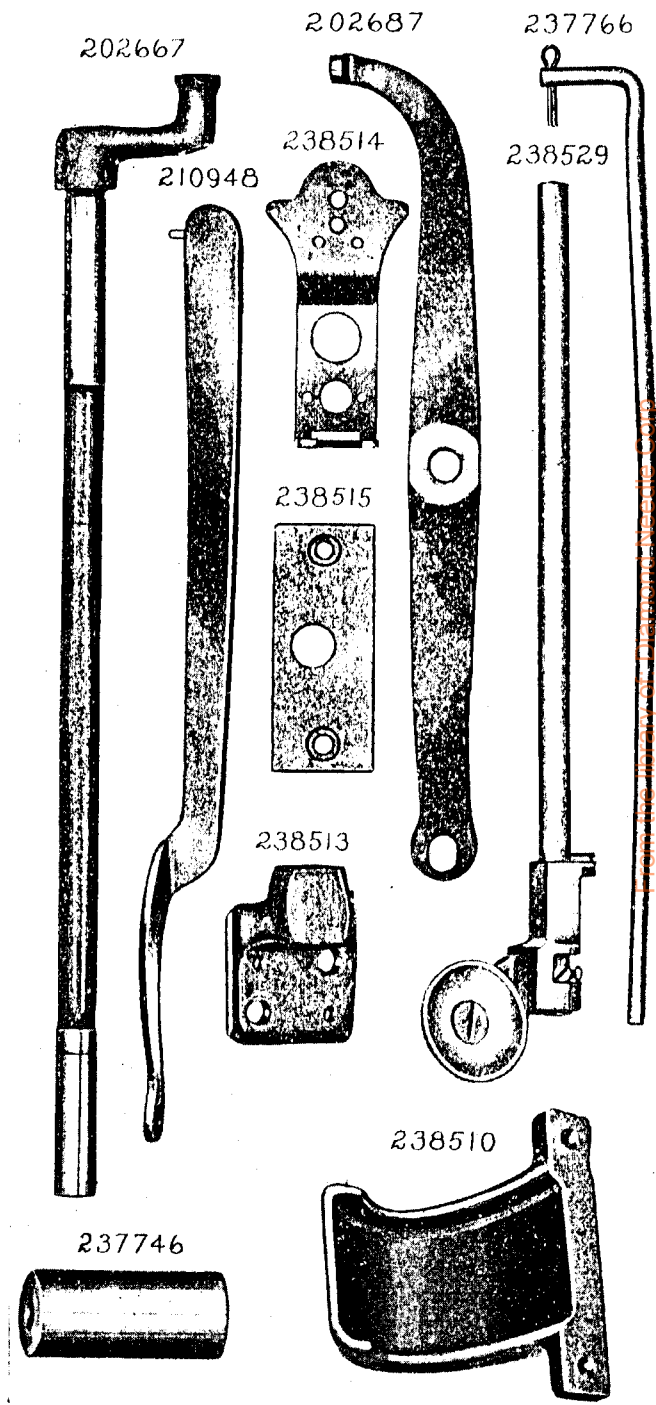


PLATE 14379—FULL SIZE

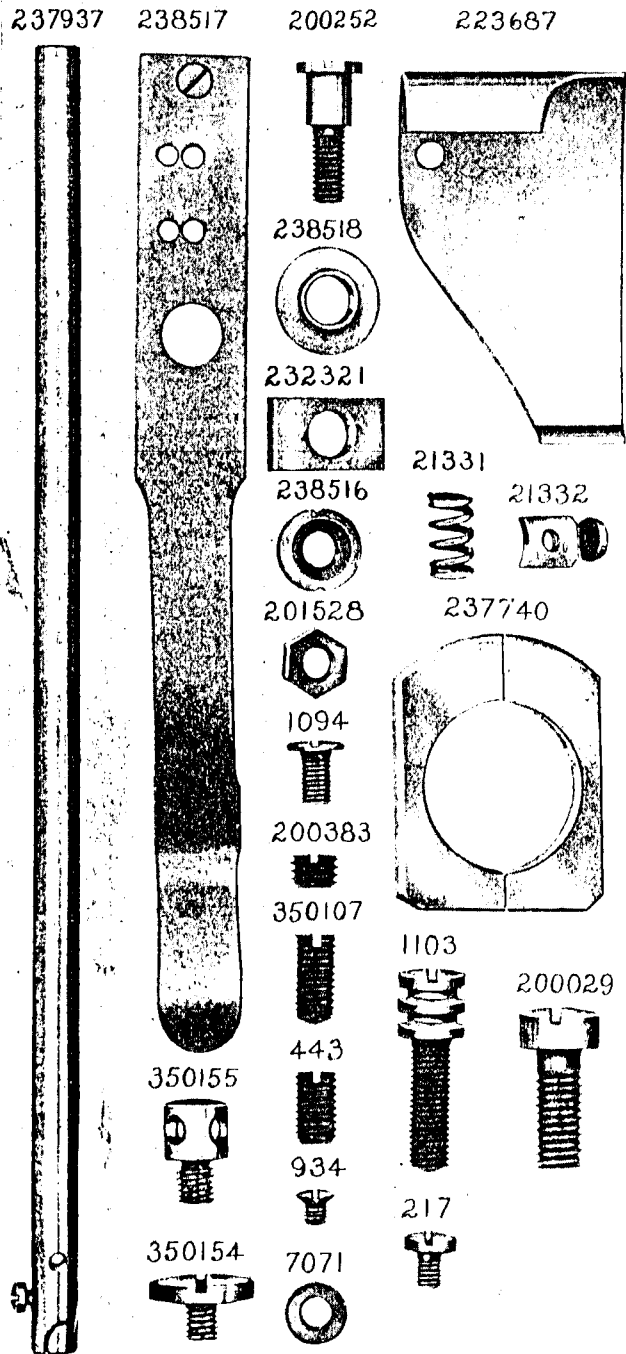
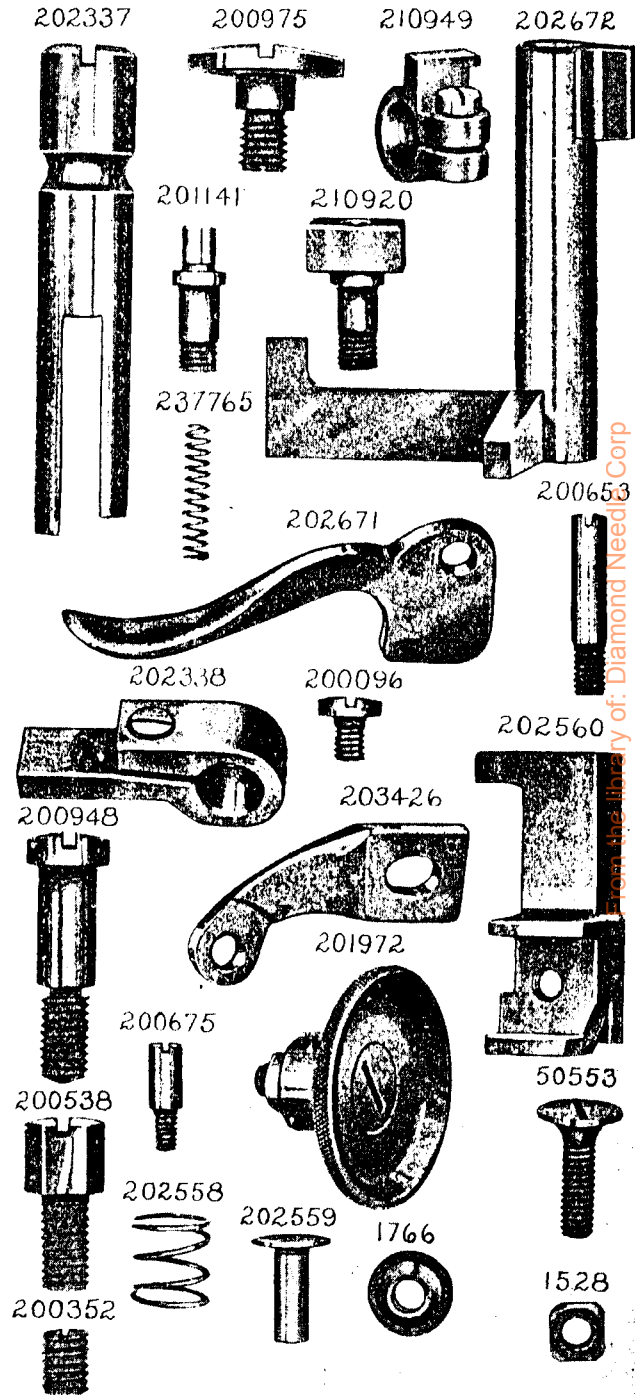


PLATE 14380—FULL SIZE



From the library of: Diamond Needs Corp

PLATE 14381—FULL SIZE

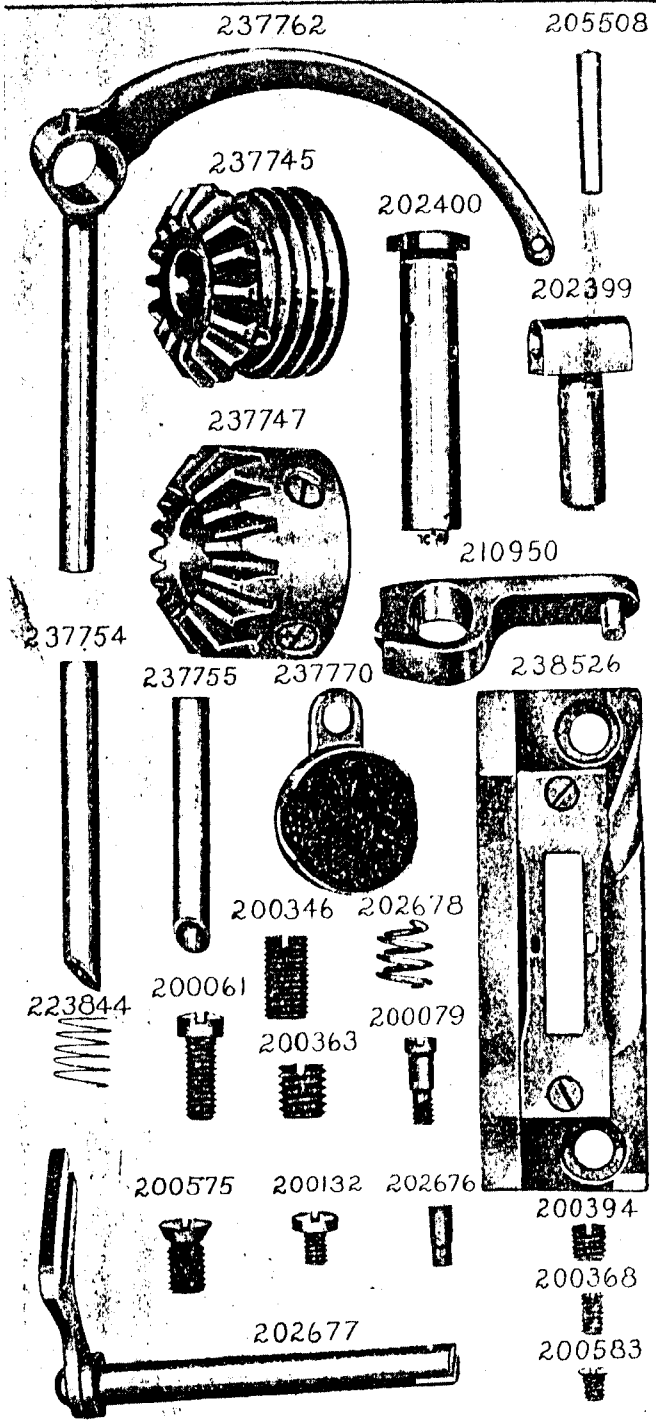
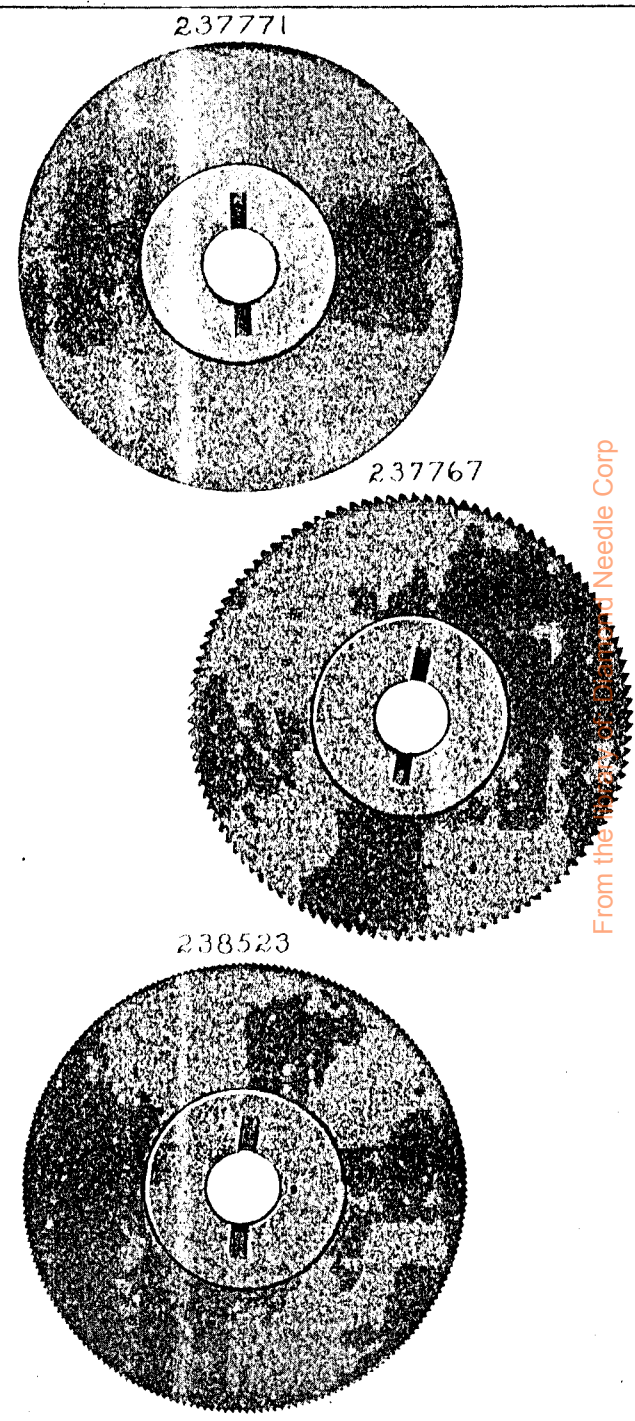


PLATE 14382—FULL SIZE



From the works of Ingersoll and Needle Corp

PLATE 14383—ONE-HALF SIZE

225497



225554



225498



41400



120342

120343

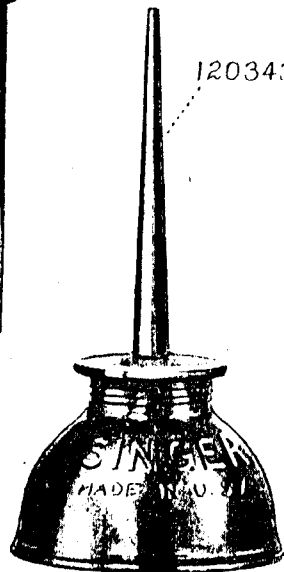


PLATE 14384—ONE-FOURTH SIZE

202451

227787

227728

202454

227781

202453

